



Model Based Design approach for Implementation of PHEV Energy Management

Morteza Montazeri-Gh^{1*}, Masoud Khasheinejad¹, Zeinab Pourbafarani¹

¹ Department of Mechanical Engineering, Iran University of Science and Technology, Box 16844-13114 Tehran, Iran

ARTICLE INFO

Article history:

Received : 05 Apr 2019

Accepted: 29 May 2019

Published: 01 June 2019

Keywords:

Model-based design (MBD)

Implementation

Plug-in hybrid electric vehicle (PHEV)

Hardware-in-the-loop (HIL)

ABSTRACT

Hardware implementation of the Plug-in hybrid electric vehicles (PHEVs) control strategy is an important stage of the development of the vehicle electric control unit (ECU). This paper introduces Model-Based Design (MBD) approach for implementation of PHEV energy management. Based on this approach, implementation of the control algorithm on an electronic hardware is performed using automatic code generation. The advantages of the MBD in comparison with the traditional methods are the capability of eliminating the manual coding complexities as well as compiling problems and reducing the test duration. In this study, hardware implementation of a PHEV rule-based control strategy is accomplished using MBD method. Also, in order to increase the accuracy of the results of the implementation, the data packing method is used. In this method, by controlling the primer and end data of the data packet transferred between the electronic board and the computer system, the noisy data is prevented from entering. In addition, to verify the performance of the implemented control strategy, hardware-in-the-loop (HIL) simulation is used with the two frequency rates. The results show the effectiveness of the proposed approach in correct and rapid implantation procedure.

1. Introduction

Considering the increasing number of vehicles in developing countries and increasing air pollution due to pollutants from fossil fuels and the lack of fossil fuel resources, the hybrid electric vehicle (HEV) technology is growing rapidly. Plug-in hybrid electric vehicle (PHEV) is a hybrid car that can be recharged with power grid to reduce vehicle fuel consumption. In a hybrid car, the control strategy can manage the internal combustion engine in the optimal operating region and reduce the amount of pollutants produced by the vehicle. Therefore, it is important to manage

automotive energy sources and to split the required power between motor and engine.

The central control unit in a hybrid vehicle controls the operation of engine and electric motor in the optimal operating conditions [1]. Due to the complexity of the hybrid vehicle control unit, in recent years the use of hardware-in-the-loop (HIL) simulation has been highly regarded in the development of control systems used in these vehicles. In 2004, Whiston introduced a HIL simulation system that can verify the vehicle's power control system software [2]. In [3, 4], using the Model-based design (MBD) method and HIL simulation, faults were identified and resolved in

* Morteza Montazeri-Gh

Email Address: montazeri@iust.ac.ir

10.22068/ijae.9.2.2958

the shortest possible time in test and development phase. In [5], HIL simulation is used to confirm the performance of the designed control strategy for a hybrid vehicle. The main step in HIL simulation is to provide the software code of the system controller. In the model-based design, this code is generated automatically from the controller model. In [6], using automatic code generation from MATLAB / SIMULINK model, a brushless DC electric motor has been controlled. The verification of the controller implementation has been done by comparing with simulation in Matlab/Simulink software. Matlab software, in addition to the real-time simulation capabilities, can generate the code automatically and connect to the electronic board and directly program the micro controller. Toyota has utilized MBD method to design and validate controllers in their latest hybrid vehicles [7]. Implementation and validation of PHEV control strategy with MBD method have been addressed in few researches with inadequate reports.

In this paper, Model-Based Design (MBD) approach for implementation of PHEV energy management is presented. For this purpose, the MBD steps are firstly described for control system development including MIL, hardware implementation and HIL. The model of a PHEV control strategy is developed in the MATLAB / SIMULINK environment and to improve the accuracy of the implementation results, the data packing method has been used. Then, using the automatic code generation, the control algorithm is implemented on the Hardware. In this way, the electronic board is ready for operation in a real system. Finally, the HIL simulation with the two frequency rates has been done to investigate the performance of the designed controller using MBD for PHEV energy management.

2. Control system development using MBD method

In this section, MBD method is introduced. The steps of control system development using MBD method along with the description of each stage are then described.

2.1. Model Based Design

Model-based design is an approach to develop efficient solutions for complex engineering problems. In this method, complicated systems can be created by using mathematical models representing system components and their interactions with their surrounding environment.

These models have many applications in the design process, including system simulation, stability analysis, and control algorithm design. These models can be used as the input to an automatic code generation tool. MBD method could help to identify weak places and mistakes in design. If the model is incomplete or not accurate, using the results of software simulation, the model can be modified in the early stages of design [8]. In order to quickly develop a control system, the employment of MBD method is essential; the features of this method are described as following [9, 10]:

- A rapid integration of design testing to continuously identify faults and eliminate defects
- The troubleshooting of the algorithm using multilayer simulation
- Automatic production of software code (optimized, embeddable C source codes from model).
- Development and replication of the design using the test system
- automatic generation of the document and design reports
- Repeatable design to distribute the system to more processors and hardware pieces

2.2. MBD development controller

In order to control a system, a controller must be designed and implemented on an electronic board. An electronic board is referred as an embedded or mechatronic system. All steps of preparation a mechatronic system (HEV controller) for controlling a system (HEV) can be done using MBD method. In Figure 1, the V-diagram of control system design with the MBD method is shown; these steps are as follows:

- Determination of the design constraints of the controller
- Design and modeling of Controller
- Model-in-the-loop (MIL) simulation
- Rapid control Prototyping (RCP)
- Automatic code generation
- Software-in-the-loop (SIL) simulation
- Processor-in-the-loop (PIL) simulation
- Hardware-in-the-loop (HIL) simulation
- Final verification

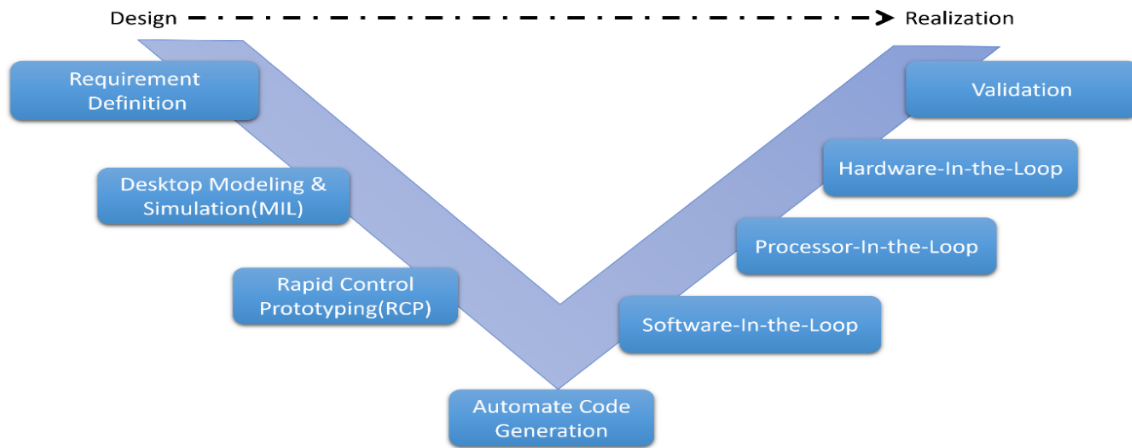

Figure 1: Model Based Design V-Diagram of a control system

From the above mentioned steps of tests and simulations, only rapid prototyping and HIL simulation are performed in real-time and MIL, SIL and PIL simulations are performed in non-real-time.

In Figure 2, the sequence of MIL, SIL and PIL simulations is shown. In MIL simulation, the controller and the system are executed as a software model in the computer system. In SIL simulation, the code generated from the control algorithm and the software system models are examined on the computer system. In PIL simulation, the code of the control algorithm is placed on the target processor and the software model of the system is located on the computer system, and the whole set is examined with the maximum possible frequency rate of the data (non-real-time running of model).

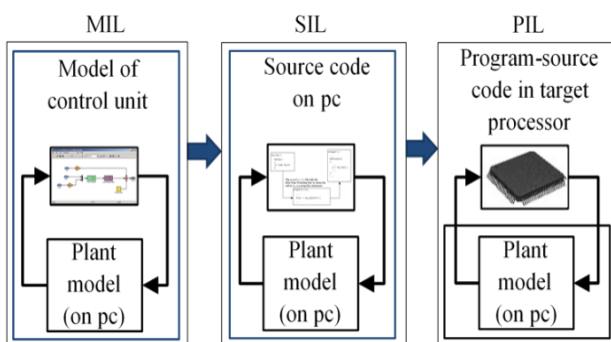
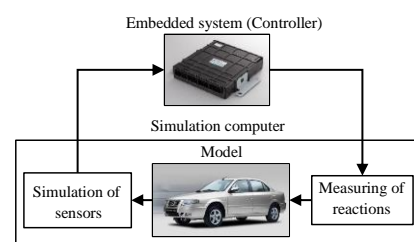
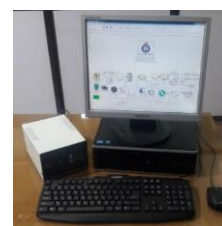

Figure 2: The sequence of MIL, SIL and PIL simulations Regular)

During the rapid prototyping, the real-time system is connected to the real-time hardware. HIL simulation is realized in a form that plant system is running as simulation in computer or in simulator and controller is implemented on an electronic board [11, 12]. After that, the HIL simulated object can be substituted with real object, which represents the comprehensiveness of HIL simulation compared to other tests and simulations performed in the early stages of MBD method [9]. In Figure 3, schematic and real implementation of HIL test is presented.



(a) Schematic



(b) Real

Figure 3: HIL testing and simulation, a: Schematic, b: Real

Model Based Design approach for Implementation...

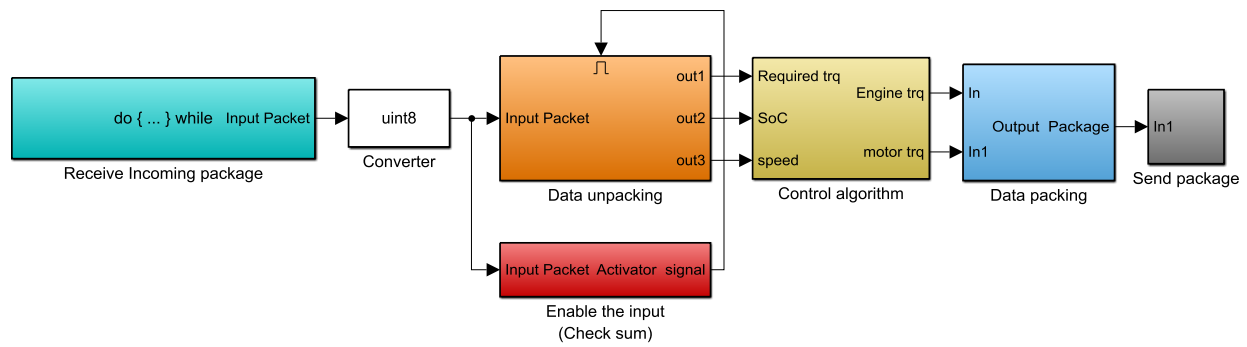

Figure 6: Control algorithm and blocks

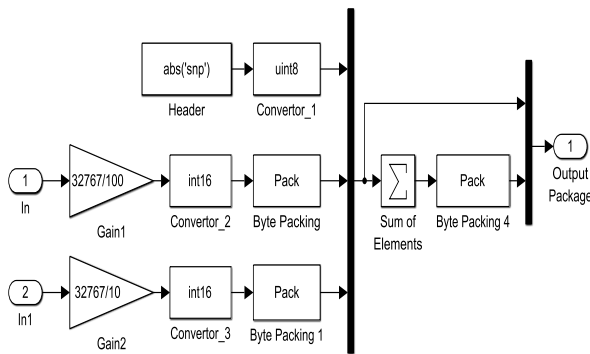

Figure 7: Data packing block

Similarly, the data sent to the electronic board is packaged. In the receiver area, the accuracy of the end and primary data is investigated. Figure 8 shows how to verify the accuracy of the end data. The precision of primary data is validated by a predefined function.

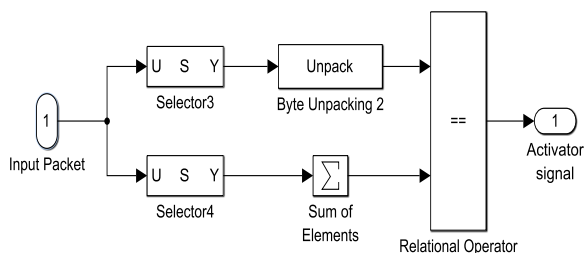

Figure 8: Checksum block

In MBD method, the software code of the controller is generated using the model of controller, and is used for electronic board programming. Specifications of the hardware used for implementation are shown in Table 1.

Table 1: Hardware specifications

Parameter	Value	Unit
Micro controller	AT91SAM3X8E (32 Bit)	---
Operational Voltage	3.3	V
Input Voltage(Limited)	6-16	V
DC Output Current	130	mA
EEPROM	512	kb
SRAM	96	kb
CPU Clock	84	MHz

Finally, using the developed controller and PHEV models previously mentioned, the verification of implementation is carried out through HIL simulation.

4. Results and Discussions

In this section, the results of the MBD based hardware implantation of the PHEV control strategy are presented using HIL test. In this research, 115200 bps (bits per second) is considered as baud rate of simulation. In

et al.

Figures 9-11, diagrams of the electric motor and internal combustion engine torque, and battery state of charge results of MIL and HIL simulation with the frequency rate of 100 Hz are shown, respectively. As shown in Figure 9, time delay between MIL and HIL simulation is 0.95S approximately. The time delay in Figures 10-11 is nearly equal to Figure 9. Due to the fact that the vehicle longitudinal dynamic is not very fast, this amount of delay is acceptable, which indicates that the selected hardware for controller is suitable for this application. Also, the results of these two tests are highly matched, which indicates the effectiveness of data packing and MBD method.

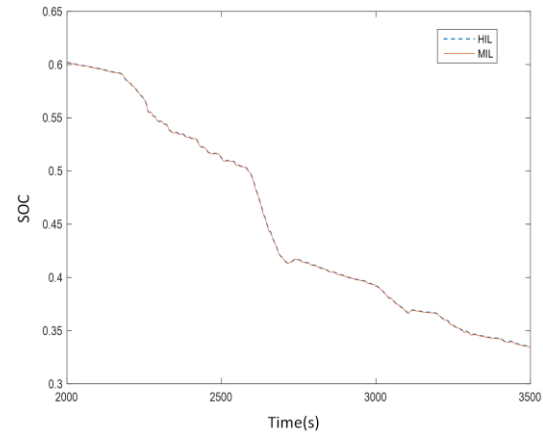

Figure 11: State of charge of battery (freq. rate: 100Hz)

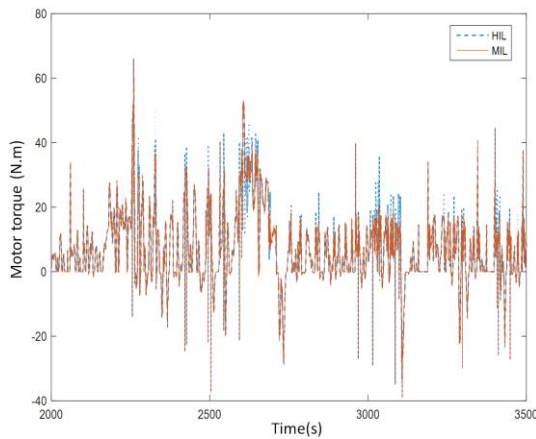

Figure 9: Motor torque (freq. rate: 100Hz)

In order to investigate the effects of frequency rate on the noise and delay of transmission signals between the electronic board and computer system, diagram of electric motor torque obtained from HIL simulation with the frequency rate of 1000 Hz is shown in Figure 12. In this condition time delay between MIL and HIL simulation is 0.22S. Also, the engine torque diagram obtained from HIL testing with two frequency rates 100 and 1000 are very close together.

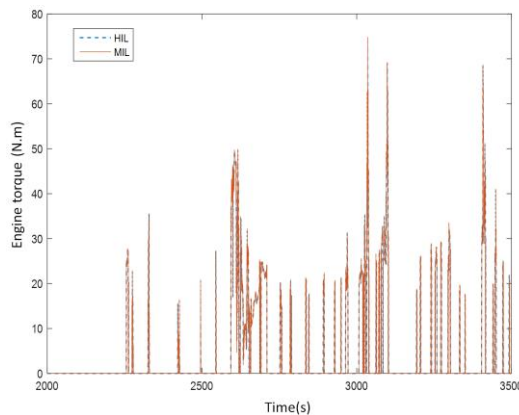

Figure 10: Engine torque (freq. rate: 100Hz)

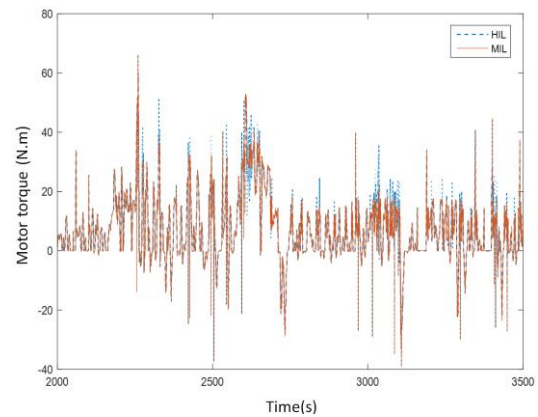

Figure 12: Motor torque (freq. rate: 1000Hz)

5. Conclusion

In this research, PHEV energy management is implemented by applying model-based design method. In order to verify the performance of the implemented control strategy, hardware-in-the-loop (HIL) simulation is performed. The real time simulation has been done on a computer system, with the controller as external hardware. Thus, the time of PHEV control system development is significantly reduced. Furthermore, the results show that by applying MBD method for implementation, controller hardware has acceptable behaviour in comparison with the software simulation, which implies the effectiveness of MBD method. In addition, the results show that data packing method used for data transfer and receive between the electronic board and the computer, is effective in improving the performance of the electronic board.

References

- [1] H. He, R. Xiong, K. Zhao, Z. Liu, Energy management strategy research on a hybrid power system by hardware-in-loop experiments, *Applied Energy*, vol. 112, pp. 1311-1317, 2013.
- [2] S. Nabi, M. Balike, J. Allen, K. Rzemien, An overview of hardware-in-the-loop testing systems at Visteon, SAE paper 2004-01-1240, Vol. 5, 2004.
- [3] X. Yang, B. Kirby, Q. Zhao, Y. Ma, F. Xu, "Model-based design process for product development of substation IEDS", Proc. IEEE Energycon Conf. Exhib., pp. 968-974, 2012A.
- [4] R. Mayyas, S. Kumar, P. Pisu, J. Rios, P. Jethani, Model-based design validation for advanced energy management strategies for electrified hybrid power trains using innovative vehicle hardware in the loop (vhil) approach, *Applied Energy*, vol. 204, pp. 287-302, 2017.
- [5] L. Wang, Y. Zhang, C. Yin, H. Zhang, C. Wang, Hardware-in-the-loop simulation for the

design and verification of the control system of a series-parallel hybrid electric city-bus, *Simulation Modelling Practice and Theory*, Vol. 25, pp. 148-162, 2012.

[6] V. Lambersky, Model based design and automated code generation from Simulink targeted for TMS570 MCU, Education and Research Conference (EDERC) 2012 5th European DSP, pp. 225-228, 13-14Sept, 201.

[7] J. Luo, K. R. Pattipati, L. Qiao, S. Chigusa, Model-based prognostic techniques applied to a suspension system, *Trans. Systems Man and Cybernetics*, vol. 38, pp. 1156-1168, 2003.

[8] M. Ahmadian, Z. Nazari, N. Nakhaee, Z. Kostic, Model based design and SDR, DSPenabledRadio 2005. The 2nd IEE/EURASIP Conference on (Ref. No. 2005/11086), pp. 8, Sept 2005.

[9] Lubica Miková, Michal Kelemen, Ivan Virgala, Tomáš Lipták, Model Based Design of Embedded Systems, *Journal of Automation and Control*, vol. 5, no. 2, pp. 64-68, 2017.

[10] M Mansour Ahmadian, Nory Nakhaee, and Andrew Nesterov, Rapid Application Development (RAD) and code optimization technique, *Global Signal Processing Conference (GSPx)*, 2004.

[11] X. Hu, J. Jiang, B. Egardt, D. Cao, Advanced power-source integration in hybrid electric vehicles: Multicriteria optimization approach, *IEEE Trans. Ind. Electron.*, vol. 62, no. 12, pp. 7847-7858, Dec. 2015.

[12] Millo Federico, Zhao Jianning, Rolando Luciano, Cubito Claudio, Fuso Rocco, Optimizing the design of a plug-in hybrid electric vehicle from the early phase: an advanced sizing methodology, *Comput-Aid Design and Applications*, vol. 12, no. 1, pp. 22-32, 2015.

[13] M. Bostanian, S. M. Barakati, B. Najjari, and D. M. Kalhori, A Genetic-Fuzzy Control

et al.

Strategy for Parallel Hybrid Electric Vehicle, vol. 3, no. 3, 2013.

[14] M. M. Tehrani, M. R. Hairi, V. Esfahanian, and M. Amiri, "Design of an Anti-Lock Regenerative Braking System for a Series Hybrid Electric Vehicle," vol. 1, no. 2, pp. 14–27, 2011.

[15] M. R. E. Shaker, A. Ghaffari, A. Maghsoodpour, and A. Khodayari, "GPS / INS Integration for Vehicle Navigation based on INS Error Analysis in Kalman Filtering," vol. 6, no. 4, 2017.